

iWALK 2.0

User Guide

1 Assembly 

2 Fitting 

3 Use 



FASTEST WAY TO LEARN
Watch instructional
videos on our website:

www.iwalk-free.com/help



Foreign Language Versions / Versions en langue étrangère
www.iwalk-free.com/user-manuals/



FOR YOUR SAFETY AND SUCCESS, READ ALL
INSTRUCTIONS PRIOR TO FIRST TIME USE.
IMPROPER FITTING OR USE CAN RESULT IN
INJURY.

Before you start! Is iWALK 2.0 right for you? MINIMUM REQUIREMENTS

A MINIMUM PHYSICAL ABILITIES



1. STAIR TEST

Before your injury, could you fluidly walk up and down stairs at normal speed, *without* using the hand rail?



2. BALANCE TEST

Can you balance on one foot for at least 30 seconds?

 • NO to either – The iWALK2.0 will not work for you

 • YES to both – Proceed to Section B

B CAPACITIES



- HEIGHT – You are between 4'10" and 6'6" (147.5cm – 198.0cm).
- You weigh 275 pounds (125kg) or less.
- THIGH CIRCUMFERENCE – Top of thigh is 28" (71.0cm) or less

 • NO to any – The iWALK2.0 will not work for you

 • YES to all – Proceed to Section C

C OTHER REQUIREMENTS



- You will read all the instructions before attempting to use iWALK2.0s
- You will follow all instructions for fitting and first time use
- If possible, you will view our instructional videos at: www.iwalk-free.com/help (*replaces written instructions*)
- After proper fitting, you will allow up to 30 minutes for learning to walk with the device

 • NO to any – The iWALK2.0 will not work for you

 • YES to all – Proceed to Section D

D AGE LIMITS



If you are over 55, iWALK2.0 might not work for you.



Physical ability is more important than age. And physical ability is variable from person to person. So *regardless of age*, if you meet ALL the requirements of A,B and C, then iWALK2.0 should work for you.

If you are over 55, be honest in your self-assessment. Your safety and satisfaction depend on it.

 • NO – (You do not meet all criteria of A,B and C) – iWALK2.0 will not work for you



 • YES – (You meet all criteria of A, B and C) – Proceed to Section E

E**iWALK 2.0 SIZE CHART - based on user's height**

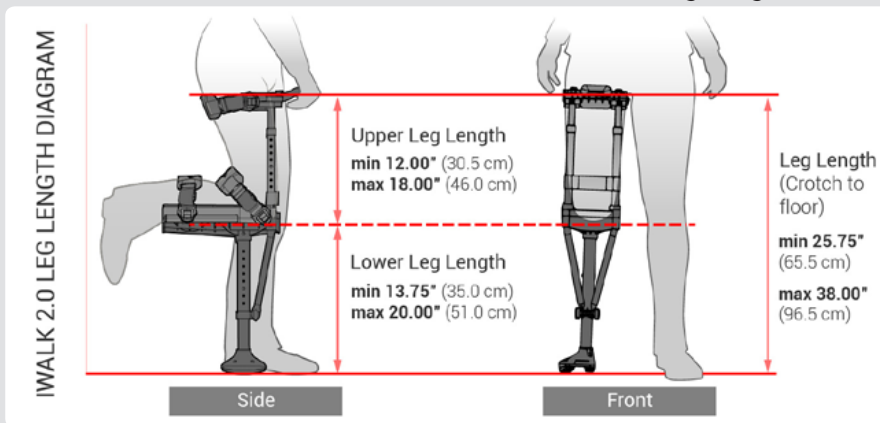
4'10" to 5'1" 147.5 cm to 155.0 cm	5'1" to 6'1" 155.0 cm to 185.5 cm	6'1" to 6'6" 185.5 cm to 198.0 cm
Review the Leg Length Diagram below. 	The iWALK2.0 will fit you. Proceed to next page	Review the Leg Length Diagram below. 

F**iWALK 2.0 SIZE CHART - based on user's leg length****NO** – (Your leg is outside the ranges shown – iWALK2.0 will not work for you)**YES** – Your leg length is within the ranges shown – iWALK WILL WORK FOR YOU! Proceed to next page

LEARN TO USE YOUR iWALK 2.0 IN 3 EASY STEPS

1	 ASSEMBLY	4 to 6
2	 FITTING	7 to 16
3	 USE	17 to 24
	Repackaging	25 to 29

Assembly Instructions



LEARN FASTER! View **INSTRUCTIONAL VIDEOS** instead!
www.iwalk-free.com/help

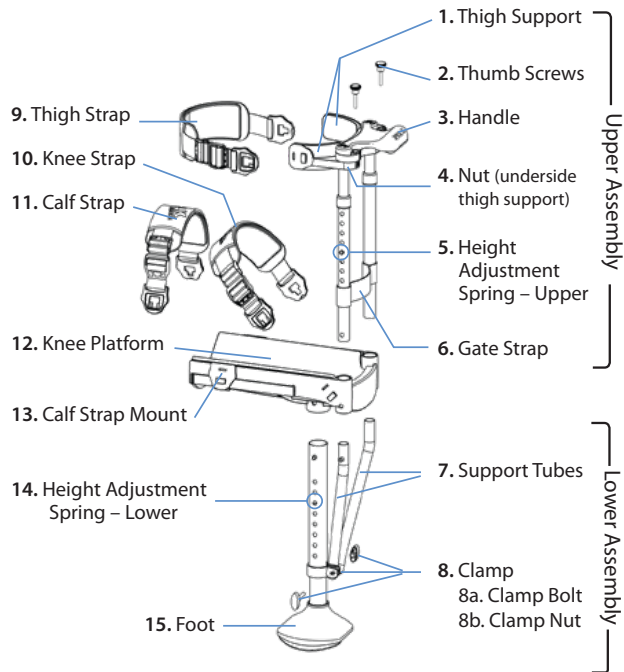

STEP 1

Insert Upper Assembly tubes into Knee Platform (12)

- ⚠ Handle must face forward.
- ⚠ BOTH tubes must be touching the bottom of the sockets.

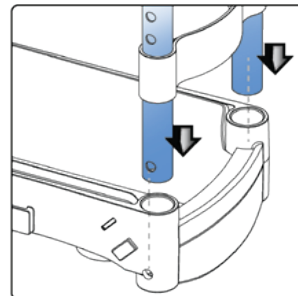

- 🖐 ⚠ Holes at bottom of tubes must align with holes in Knee Platform. Confirm that holes align on Left and Right sides.

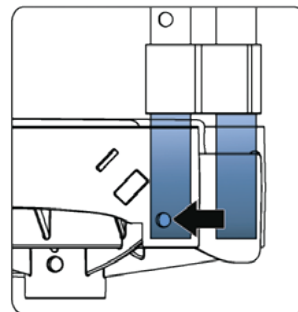

- 💡 If Left side hole does not align:
 1. Confirm tube is fully extended
 2. Rotate tube until hole in tube aligns with hold in Knee Platform

STEP 2

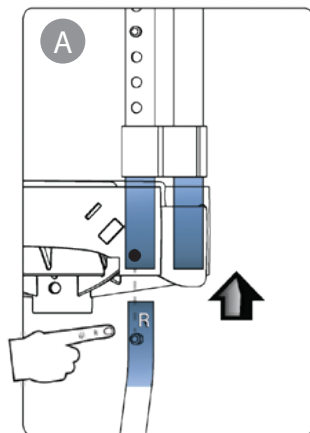

A) Identify Right Support Tube (7) by letter "R"

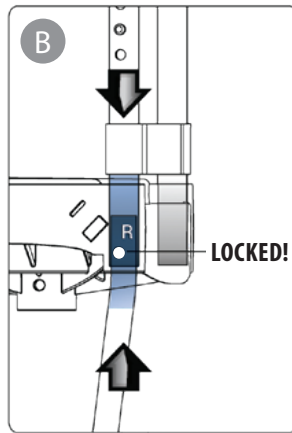

B) Push the silver spring head and insert Support Tube (7) into Knee Platform (12). Keep downward pressure on Upper Assembly Tube while inserting. You are done when the silver spring head fills the hole in the Knee Platform. *Hint – if spring does not fill the hole, wiggle the tubes until spring head pops out.*

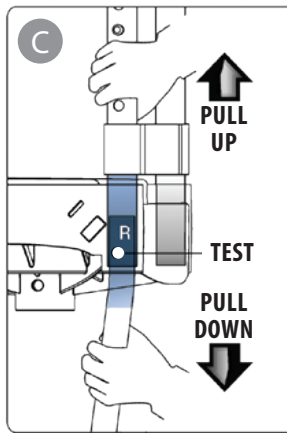

C) Test the connection! Simultaneously pull UP on the Upper Assembly tube while pulling DOWN on the Support Tube (7). It must be impossible to pull them apart. TEST BOTH LEFT AND RIGHT CONNECTIONS.



WARNING – Upper Assembly tube, Support Tube (7) and Knee Platform (12) must all be locked together. Confirm for Left and Right sides. If not locked, instability and injury can result.

STEP 3

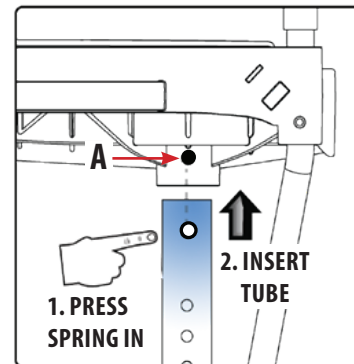

Attach Lower Assembly to Knee Platform (12).

1. Press in spring head
2. Insert tube until spring head fills hole A.
3. Test connection. Grasp tube and pull down forcibly. Confirm tube is locked into Knee Platform.

STEP 4

Clamp (8) should be centered between ends of Support Tubes (8) and centered on slot as shown. If necessary, use screwdriver or similar to rotate Clamp (8) into position.

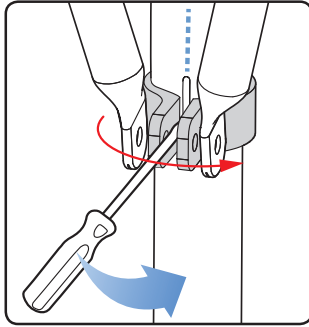

Push ends of tubes to align Support Tube holes with holes in Clamp. Insert Clamp Bolt (8a) and thread onto Clamp Nut (8b). Do not tighten yet.

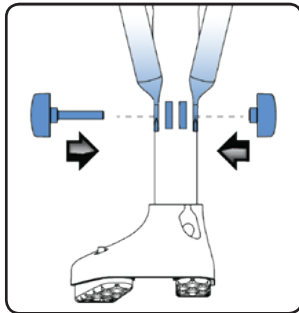

STEP 5

Connect Thigh Supports (1) to Handle (3)

1. Insert Thumb Screws (2) into slots in Handle.
2. Raise Thigh Supports and thread Thumb Screws into the nuts located on underside of Thigh Supports.
3. Do not fully tighten. Ensure that Thigh Supports can rotate on tubes.

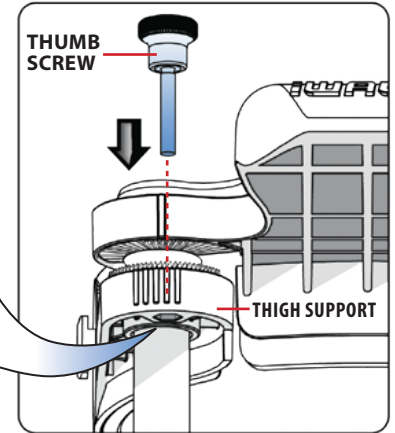
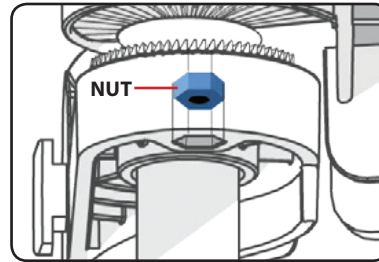

When threading the nut, PUSH DOWN LIGHTLY to prevent pushing the nut out of the socket.

If Thumb Screw will not tighten, confirm that the nut on underside of Thigh Support is in place. If missing, check your work area to see if it has been accidentally pushed out.

If nut is missing, do not panic. Nut is standard M5 x .8, available at most hardware stores, or call us for replacement.

Fitting Instructions



LEARN FASTER! View INSTRUCTIONAL VIDEOS instead!
www.iwalk-free.com/help

Proper fit is **essential!** But it's also **easy**. Get these three things right and you'll be iWALKing in minutes. We'll show you how.

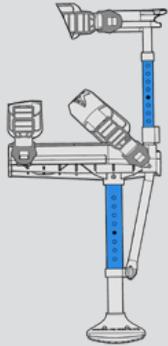

Height

Adjust both the upper and lower section of the crutch to the correct height.

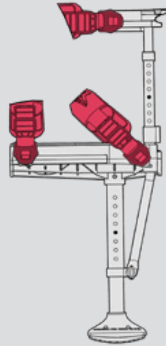

Tight

For control and stability, you want the straps tight!
 Really, really tight!

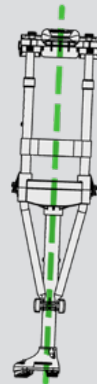

Vertical Alignment

Essential for quick learning, and often overlooked, the vertical angle controls where the foot will be positioned.

STEP 1

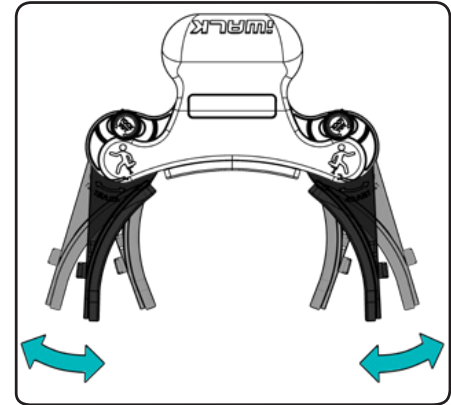

Make sure Thigh Supports (1) can rotate freely. Loosen Thumb Screws (2) if necessary.

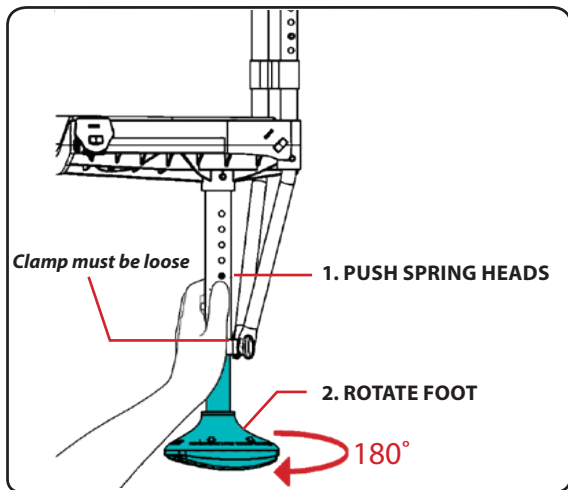

POSITION FOOT FOR LEFT OR RIGHT LEG USE

⚠ Curved edge of foot must be positioned toward outside

1. Loosen Clamp Nut (8b)
2. Press in adjustment springs as shown
3. Grasp foot and rotate until spring heads pop out of holes.

Note - The Foot and lower tube will rotate . The upper tube stays stationary.



Incorrect

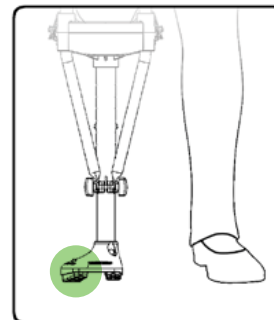

Correct

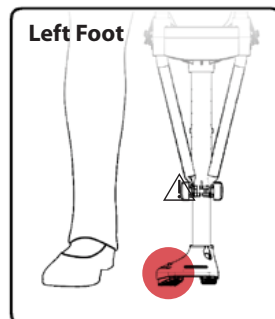

Incorrect

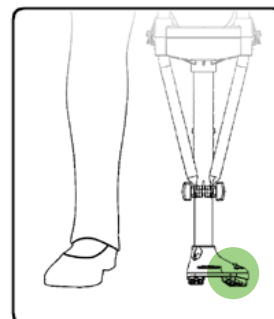

Correct



Improper orientation of the Foot causes instability which could result in a fall and/or injury.

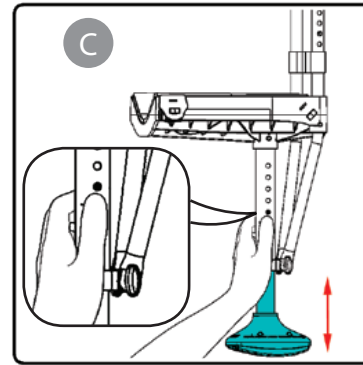
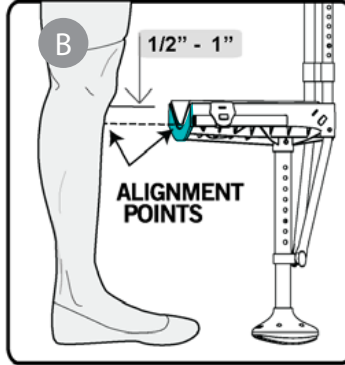
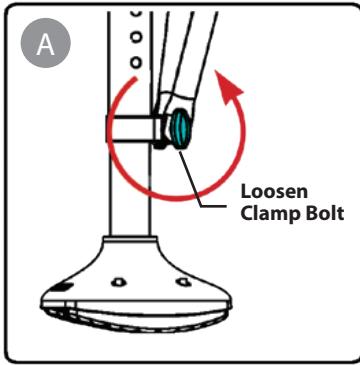

LOWER LEG HEIGHT ADJUSTMENT

- A. Loosen Clamp Nut (8b)
- B. Check height – For first time use, proper height is when center of pad, at back edge of Knee Platform (12), aligns $\frac{1}{2}$ to 1" below bottom of your knee cap. Note – slightly too low is better than too high.
- C. Adjust height by pressing in the two spring heads. Grasp foot and rotate slightly while pushing up to shorten or pulling down to lengthen. Repeat until correct height is achieved.

Note – After you have basic proficiency walking, you will readjust height to have equal leg length.

 Before putting weight on the crutch, make certain that both spring heads are fully engaged ("popped out") in the adjustment holes. Then tighten the Clamp Bolt. Failure to do so could result in a fall and / or injury.

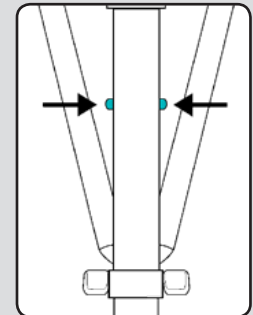

STEP 4

UPPER LEG HEIGHT ADJUSTMENT

Press the push button spring head and pull up on Handle (3) until the Thigh Supports (1) are as high as possible on your leg. Make sure spring head pops all the way out of hole to lock your setting.

Note – If spring does not pop out initially, grasp handle firmly and rotate back and forth – spring head will pop out.

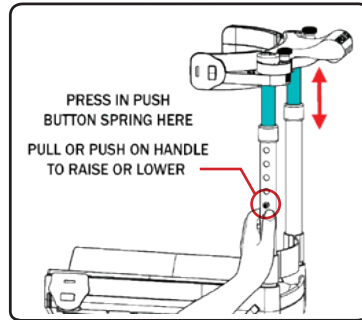

Correct position at top of leg promotes stability.

Incorrect position below top of leg causes instability.

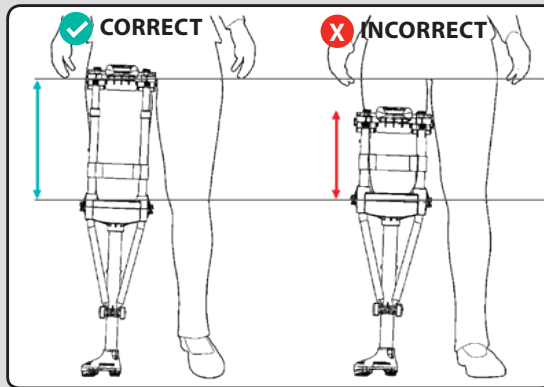

STEP 5

VERTICAL ALIGNMENT – POSITIONING

1. Find a hard, level surface
2. Grasp the Handle for support
3. Place the crutch Foot (15) on the ground shoulder width apart from your good foot as shown.
4. Kneel on the crutch.
5. Put 50% of your weight on the crutch, and 50% on your good leg.

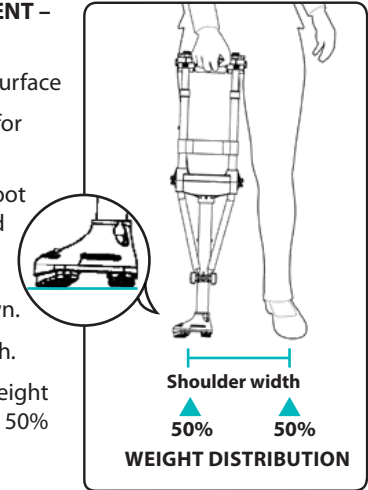

1. The goal is to position the crutch Foot where your human foot would normally be.
2. You will naturally put most of your weight on your good leg. Don't – it's important that 50% of your weight is on the crutch.

⚠ Keep firm grip on Handle. Use an assistant if you are not confident in your ability.

VERTICAL ALIGNMENT - continued

- A. Slide knee as far forward as possible on the Knee Platform (12)
- B. With 50% of your weight on the crutch, use the Handle (3) to move the crutch left or right to give a slight outward tilt.



When properly fitted, the crutch should be angled slightly outward as shown below. Achieving the correct angle is automatic if you follow our instructions. The goal is to position the crutch so that the crutch Foot is located where your human foot would normally be. Once you have the crutch at the correct angle, hold this position and proceed to Step 7.

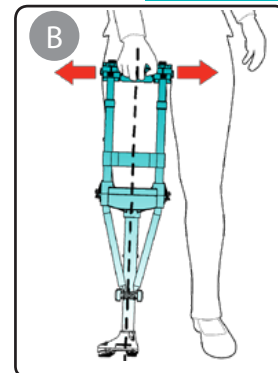
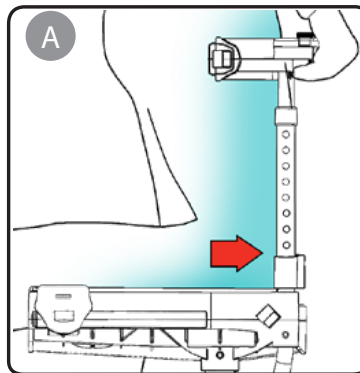

STEP 6

VERTICAL ALIGNMENT – THIGH SUPPORT ADJUSTMENTS

- A. Rotate Inner Thigh Support (1) until it contacts your inner thigh. Continue rotating the Thigh Support as far as possible, even if it pushes into your inner thigh. Lock down the position by tightening Thumb Screw (2).
- B. Rotate the Outer Thigh Support until it compresses tightly into your outer thigh. Lock the position by tightening the Thumb Screw.

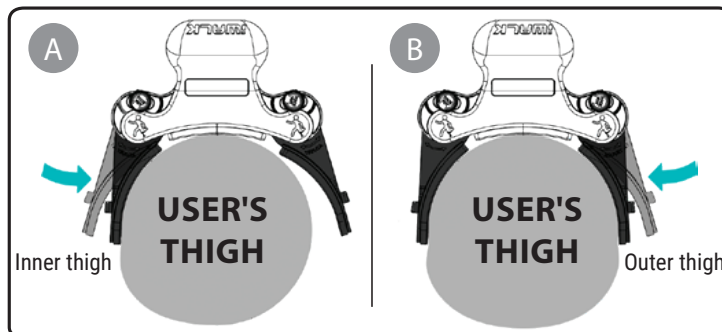

Note – The thigh supports should press into your inner and outer thigh slightly. This reduces movement of the crutch and promotes stability.

VERTICAL ALIGNMENT – FINAL ADJUSTMENT

Fine tuning the vertical alignment is important for best function of your iWALK. Follow the instructions below to tailor your iWALK to your leg geometry. Adjustments shown are for right leg. Left leg would be opposite (mirror image)

A- Angles inward (unstable!)

Loosen both Thumb Screws (2) so Thigh Supports (1) can rotate.

1. Over rotate the inner Thigh Support as shown. Lock adjustment by tightening Thumb Screw
2. Adjust outer Thigh Support so it is firmly against your thigh. Lock adjustment with Thumbscrew

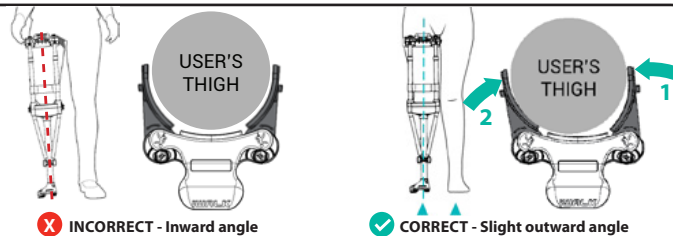

B- Angles outward (inefficient)

Loosen both Thumb Screws (2) so Thigh Supports (1) can rotate.

1. Reduce rotation of the inner thigh support as shown. Lock adjustment by tightening Thumb Screw
2. Adjust outer Thigh Support so it is firmly against your thigh. Lock adjustment with Thumbscrew

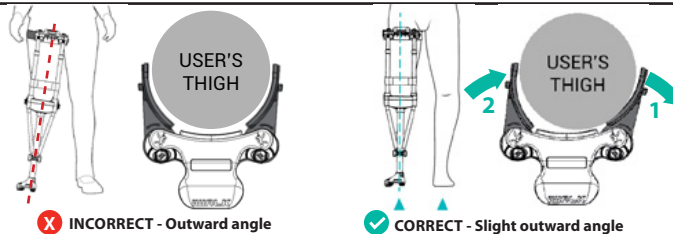

C- No Angle

Loosen both Thumb Screws (2) so Thigh Supports (1) can rotate.

1. Over rotate the inner Thigh Support as shown. Lock adjustment by tightening Thumb Screw
2. Adjust outer Thigh Support so it is firmly against your thigh. Lock adjustment with Thumbscrew

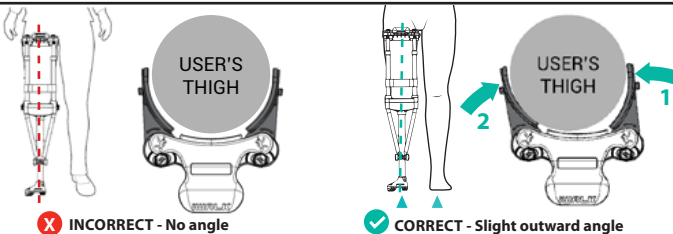

Straps Adjustment

Before you adjust the straps, you need to understand how they work.

There are two distinct sections. The Length Adjustment section and the Tighten / Loosen section. See details at right.

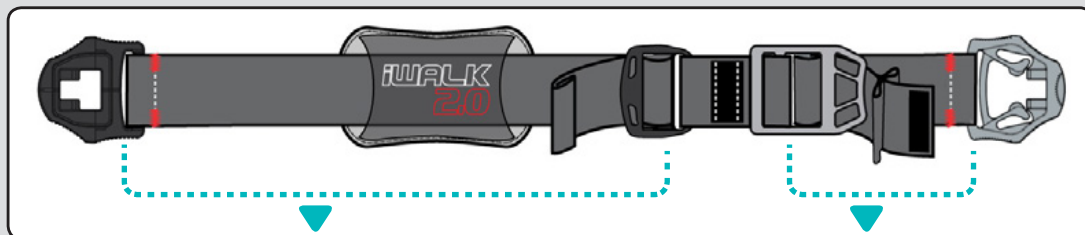

Length Adjustment Section

This section has BLACK buckles on either end.

Used only for adjusting the length of the strap to fit your leg circumference.

 *Not used for final tightening of the strap. For this, use TIGHTEN and LOOSEN section at right.*

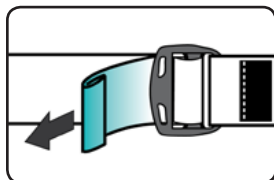

To shorten or tighten the Strap, pull on the end of the strap as shown above.

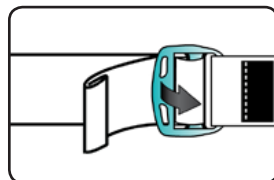

To lengthen or release the Strap, lift up on the end of the buckle.

Tighten / Loosen Section

This section has GRAY buckles on either end. Used only for TIGHTENING and LOOSENING of the strap.

TIGHTEN FULLY to achieve maximum strap tension before using the crutch.

LOOSEN for easy buckle removal (when taking the crutch off).

Different Buckle Types

T Lock Buckles are located at the ends of the Straps. They are used to attach the Straps to the crutch.

Tensionlock Buckles are used to adjust the length (and tension) of the Straps. Each Strap has two T Lock buckles and two Tensionlock buckles.

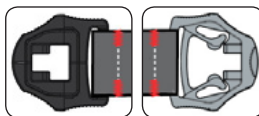

T Lock Buckles

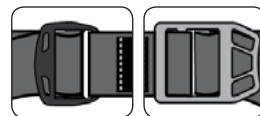

Tensionlock Buckles

Strap Installation

Before installing the Straps extend both the LENGTH ADJUSTMENT and the TIGHTEN LOOSEN sections to their maximum length.

A. Slide the Strap mounts to the back of the Knee Platform. Strap mounts can slide forward if alternate positioning is needed.

B. Install Black T Lock Buckles in the 3 positions shown in illustrations. Black buckles should be located on the inner side of your leg. B1 shows left leg, B2 shows right leg.

C. To install Black T Lock Buckles, align hole in T Lock Buckle with T Post on Strap Mounts. Pull back on T Lock Buckle until it locks into position.

Do not install Gray buckles yet – leave straps hanging for now.

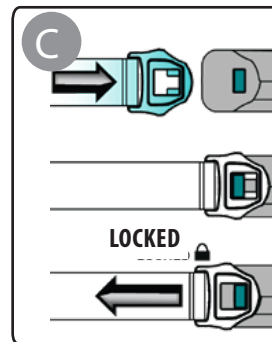
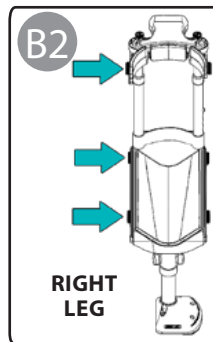
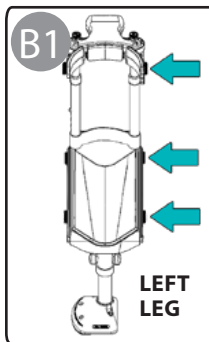
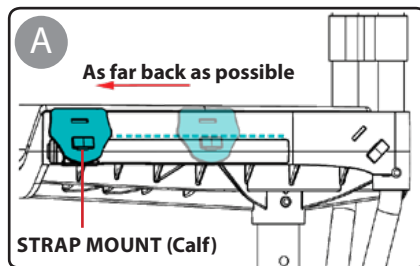

Strap Adjustment and Tightening

STEP 9

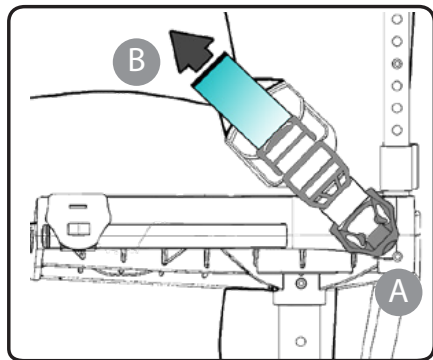

A. Position your leg on the Knee Platform (12) as far forward as possible. Drape the Strap over the back of your knee and fasten the Gray T lock buckle onto the T post of the Knee Platform.

B) Adjust the length of the strap by pulling on the end of the LENGTH ADJUSTMENT SECTION. Pull until the strap is snug, but not fully tensioned.

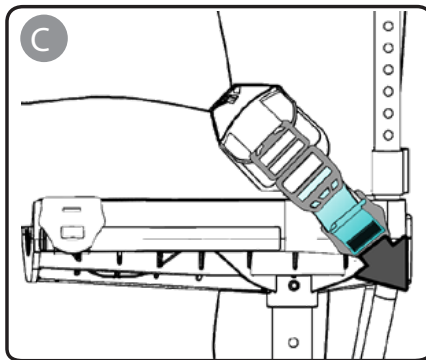

C) Fully tension the strap using the TIGHTEN / LOOSEN SECTION. Pull on the tail of the webbing until the Strap is extremely tight.

Hint - if you can slip a finger under the strap, it's too loose.

If you cannot achieve full tension, loosen the TIGHTEN LOOSEN section by lifting up on the end of the Gray Tensionlock buckle. Repeat Step 9 A and B until proper adjustment is achieved.

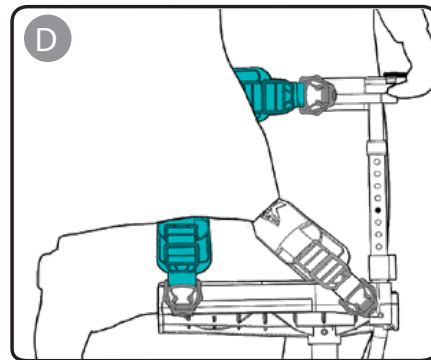

D) Repeat for upper thigh Strap and calf Strap. Reposition strap pads if needed.



When we say tight, we mean it. Seriously, tighten those straps down. If they're not super tight, don't even use the crutch. Properly tightened straps make it so much easier to learn and use the iWALK2.0. The goal is to make the crutch an integral part of your leg.

To remove crutch, reduce tension on the straps and disconnect buckles.

Order of removal:

1. Calf Strap
2. Upper Thigh Strap
3. Knee Strap

A. Lift up on Gray tensionlock buckle to reduce tension of Strap

B. Push forward on Gray T Lock buckle to disconnect from crutch

Remove calf Strap first, then upper thigh Strap. Remove knee Strap last.

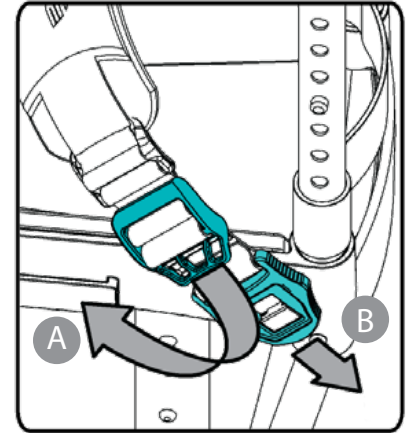

Use Instructions



LEARN FASTER! View **INSTRUCTIONAL VIDEOS** instead!
www.iwalk-free.com/help

If **PROPERLY FITTED**, it is easy to learn to walk with iWALK2.0, provided that you **FOLLOW OUR INSTRUCTIONS**. People learn at different rates - you must allow yourself at least 5-30 minutes to adapt to the device.

SAFETY CHECKLIST – BEFORE YOU WALK:

Fit

Proper fit is **ESSENTIAL**.

1. **FOOT ADJUSTMENT - LEFT OR RIGHT** – The Foot must have the curved edge on the **OUTSIDE** of your leg. See Fitting, Step 2.
2. **HEIGHT** – Confirm upper and lower leg height is correct. See Fitting steps 5-7.
3. **TIGHT** – For stability and control, Straps must be very tight. See steps 8-9 in Fitting section.
4. **VERTICAL ALIGNMENT** – So important, and often overlooked. This is essential for proper balance and learning. Do not skip this essential adjustment! See Fitting steps 5,6 & 7.
5. **FOOT POSITION** – The Foot of your iWALK2.0 must be approximately where your human foot would be. See Fitting sections 5,6 & 7.

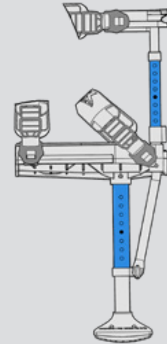

Height

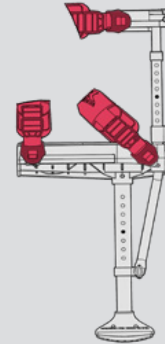

Tight

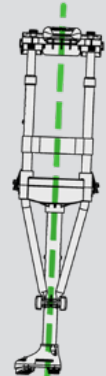

Vertical Alignment

Environment

1. Use hard, level surface. Avoid uneven surfaces or padded carpets.
2. Use area that allows walking in a straight line for at least 15 steps without stopping or turning.
3. Make sure there are no obstacles in your path.
4. A hand rail or similar is desirable but not required.
5. Hallways, corridors and balconies are good learning environments.

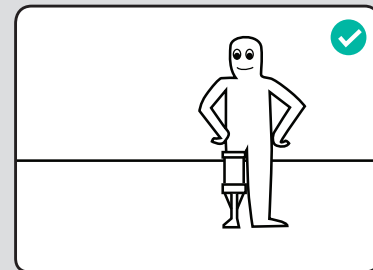
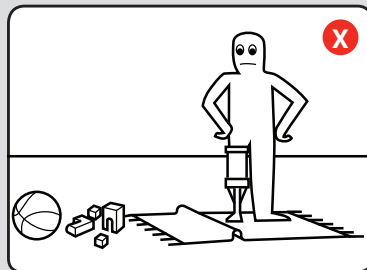

Starting Position

Always be positioned in the STARTING POSITION before you start walking:

- A. Feet side by side.
- B. Weight 50% on crutch foot, 50% on good foot
- C. Feet shoulder width apart

Walk As Normal As Possible

Walking on iWALK2.0 is very similar to normal walking. You use the same muscles and balance as normal walking. The more normal you walk, the faster you will learn. Try to relax and walk normally, the adaptations will come naturally. Try not to over think it.

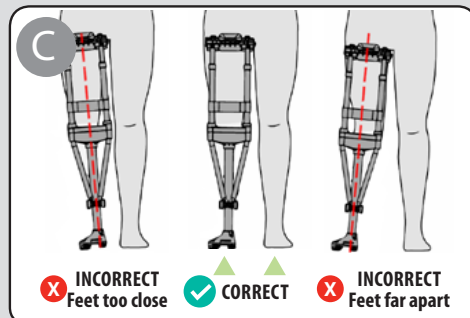
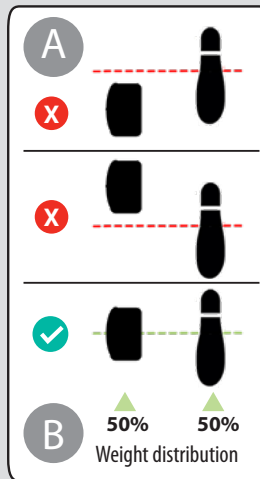

BEFORE YOU START:**AVOID COMMON MISTAKES**

- 1. DO NOT LOOK DOWN.** You will want to look down, but this causes posture that is not normal, which makes walking more difficult. Hint – find a distant object before you start walking, and continue to look at it while walking.
- 2. DO NOT “LIMP” ON THE CRUTCH.** When you lift your good foot to bring it from back to front, ALL your weight will be on your crutch foot. Beginners are often afraid of this, and will “limp” by forcing their good foot down too early. To learn quickly trust the crutch and commit 100% of your weight to the crutch leg, just like normal walking.
- 3. LEAN FORWARD.** When we walk, our body mass is in front of our feet. But we do not fall because we step forward. Many beginners are afraid to place their body mass in front of their feet at first, but you must. Also, when you start walking, don't stop! Maintain forward momentum for as long as possible – you will learn much faster.

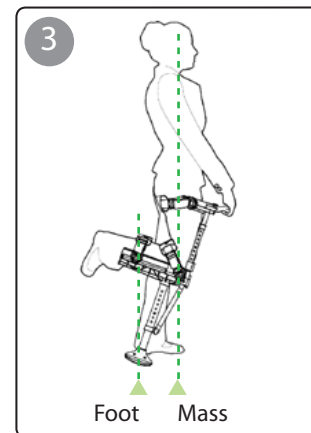
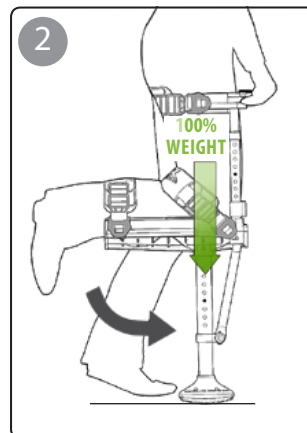
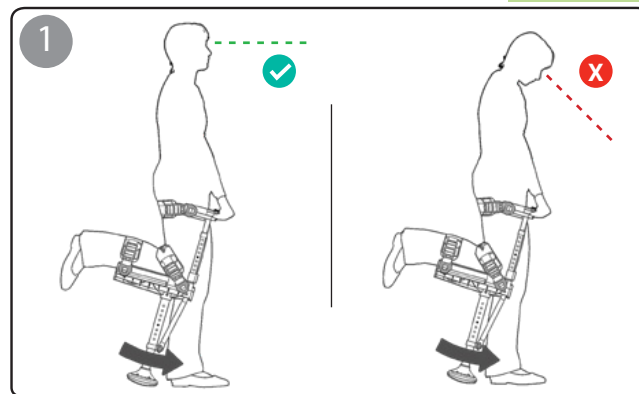

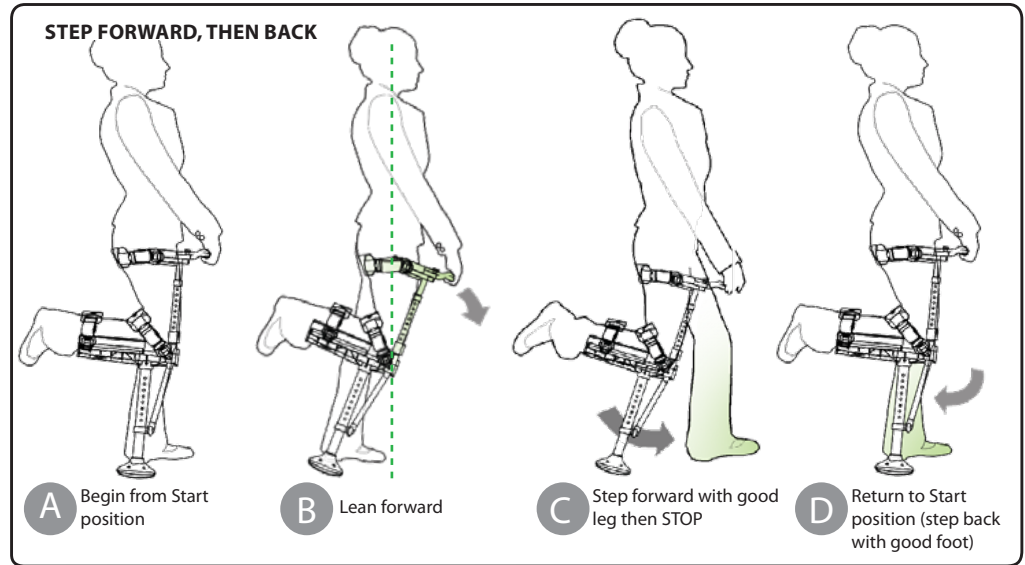
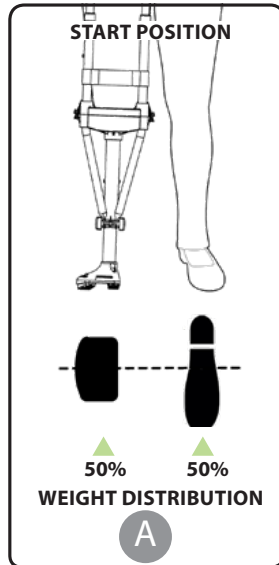
LET'S GET STARTED:**PRACTICE EXERCISE – STEP FORWARD, STEP BACK:**

A. Stand in the Start position. Feet are side by side, shoulder width apart. Your weight must be equal on both legs.

B. Grasp handle and lean crutch forward. Allow your upper body to move forward also.

C. As soon as it feels natural, step forward with your GOOD foot, then STOP.

D. Return to the Start position by stepping back with your good foot. Repeat this exercise at least four times, or until you are very confident and comfortable.

STEP 2

START WALKING:

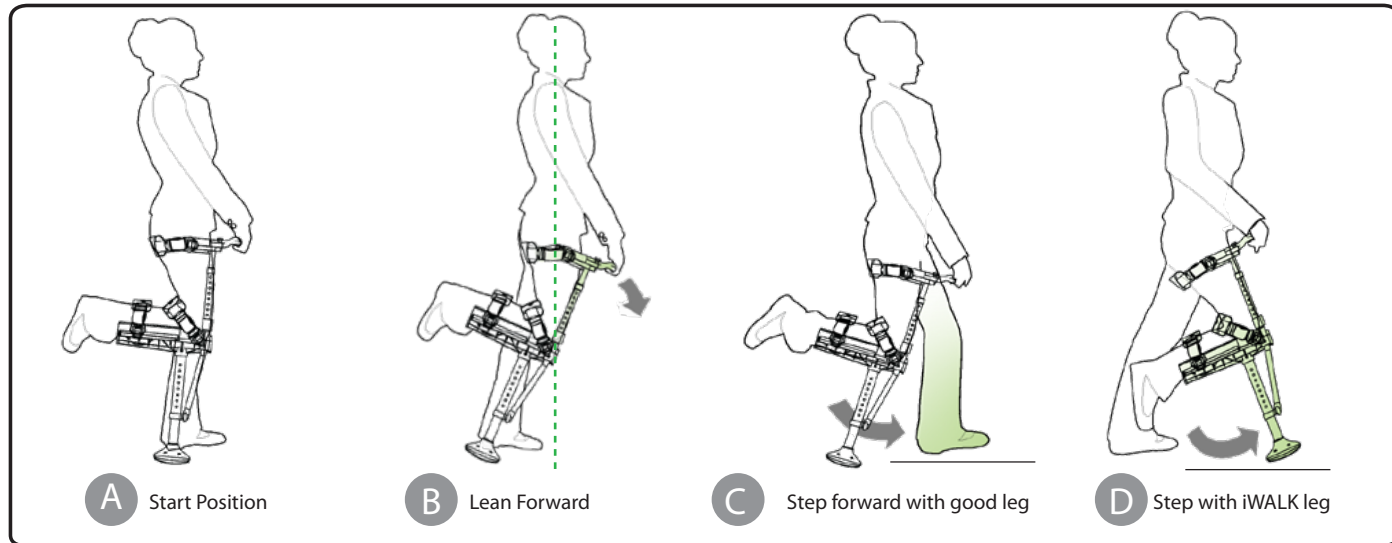

A. Stand in the Start position.

B. Same as in Practice Exercise, grasp handle and lean crutch forward. Allow your upper body to move forward of your feet.

C. As soon as it feels natural, step forward with your GOOD foot.

D. Continue walking. Step with your crutch leg, then your good leg, and continue, taking as many steps as your environment allows. Do not stop – continue walking as long as possible.



Tip 1 - If your good leg gets very tired, it means you are not committing your weight to the crutch. Remember, when your good foot goes from back to front, all your weight is on the crutch leg. This is normal, and you must not rush to put your good foot back on the ground. Try to ignore that you are wearing the crutch, and walk normally.



Tip 2 - Once you start walking, do not stop. Take as many continuous steps as your environment allows. You will learn much faster if you do not stop. If you do stop, return to the Starting position, then start walking again.

RETIGHTEN THE STRAPS

After your first few steps are completed, **RETIGHTEN** the Straps. For control and stability the Straps must **REMAIN TIGHT**. If you cannot get the straps tight enough, readjust them following the instructions in Step 9 of the Fitting section.

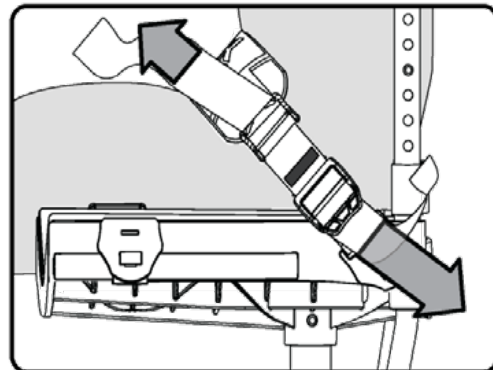

EFFICIENCY ADJUSTMENTS

Your crutch is currently adjusted to the **PHASE 1 LEARNING SETTINGS** (crutch leg slightly shorter than good leg, crutch angled outward). These settings are temporary. They make it easier to learn, but are not intended for maximum efficiency. After you've gained basic proficiency walking, change the adjustments to the Maximum Efficiency Settings.

PHASE 2 - MAXIMUM EFFICIENCY SETTINGS

- A. Remove crutch.
- B. Extend lower leg Height Adjustment until both legs are equal length. (See Fitting, step 3)
- C. Adjust Thigh Supports (1) to obtain a more vertical angle of the crutch. Alignment is correct when crutch foot is where human foot would normally be, when standing in the Start position.
- D. Practice walking and continue adjusting until you find your most efficient settings.

PHASE 1 LEARNING SETTINGS

First 3-10 minutes.
Temporary setting

Crutch angled out
(5+ degrees)

Crutch leg shorter
than good leg

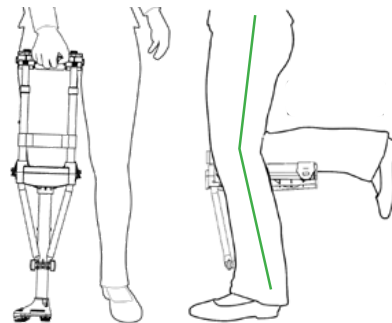

PHASE 2 MAXIMUM EFFICIENCY SETTINGS

Crutch more vertical
(2-3 degrees)

Both legs are equal
length

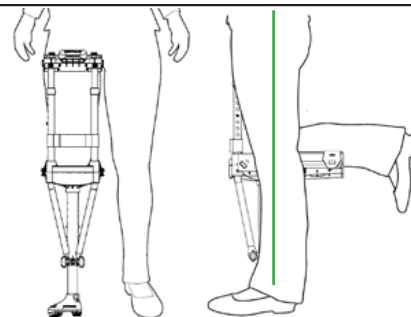

Stairs

Stairs are easy on the iWALK2.0, however, stairs should NOT BE ATTEMPTED until you've gained full proficiency.

⚠ Always use the hand rail(s) when ascending or descending stairs.

UP - Always lead with your good leg followed by your iWALK leg. Take one step at a time.

DOWN - Always lead with your iWALK leg. Take one step at a time. On steeper stairs you may need to slightly rotate your body so that the foot of your injured leg can clear the step.

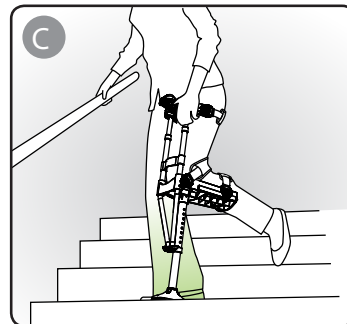
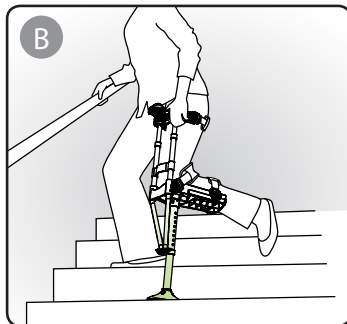
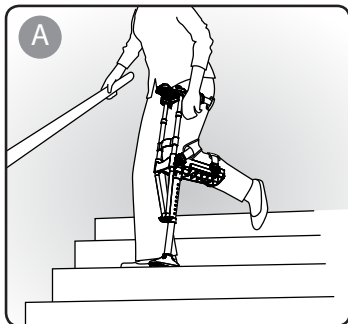
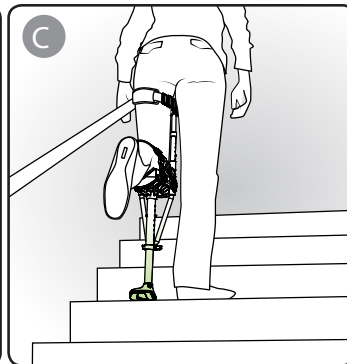
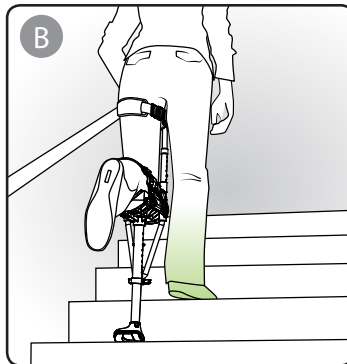
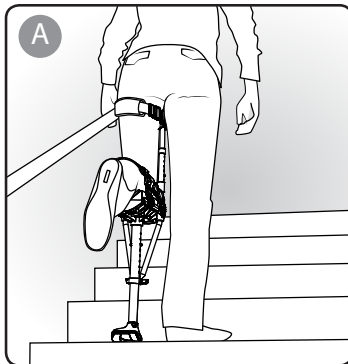

Hint - on steep stairs, you can descend by going backwards (facing up while descending). It's easier than you think!

Repackage Instructions

WHAT YOU HAVE:



SMALL PARTS BAG CONTENTS:

- 1x Strap
- 2x Thumb Screw
- 1x Clamp-Nut
- 1x Clamp-Bolt



Note - To prevent shipping damage, make sure that all metal tubes are placed back in the protective plastic bag they came in.



UPPER ASSEMBLY

KNEE PLATFORM with straps

SUPPORT TUBES

LOWER ASSEMBLY



USER GUIDE



SMALL PARTS BAG



A. Extend the tubes just enough so that you can rotate the two Thigh Supports so they nest together inside the tubes as shown.



Hint – To extend the tubes, grasp the tubes above and below the gray plastic collars and pull in opposite directions. Depress the push button spring head on the right side tube.

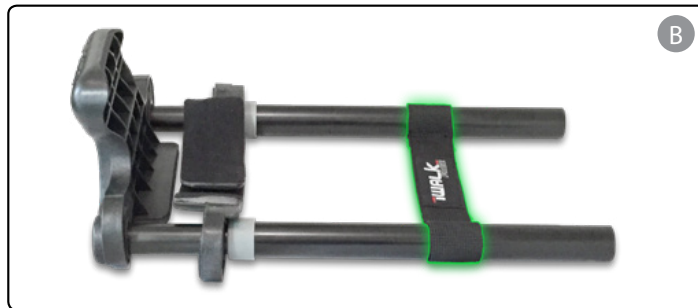
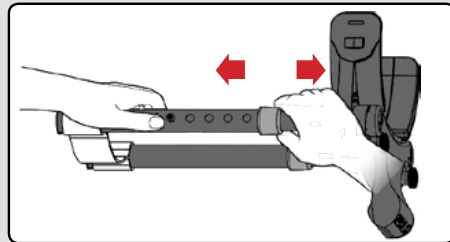

B. Lay the Upper Crutch Assembly, with Thigh Supports rotated inwards and Handle facing up (as shown), on a flat surface.

Make sure the Knee Strap is installed.

STEP 2



A. Make sure both of the straps on the Knee Platform are attached. Then tighten them all the way so that they are neat and secure.

Tuck strap tails under the pad sleeve as shown below.



B. Place the Knee Platform on top of the Upper Crutch Assembly.



⚠ VERY IMPORTANT:

Make sure the rounded part (forward edge) is placed closest to the Handle of the Upper Crutch Assembly.



A. Slide the Lower Crutch Assembly under the straps and onto the Knee Platform.



B. Place the Support Tubes on top of the Knee Platform, underneath the straps and beside the Lower Crutch Assembly.



C. Nest the bag of Small Parts on the Knee Platform between the straps and beside the Lower Crutch Assembly.



Note - Make sure the Lower Crutch Assembly tubes are at their shortest length and that curved edge of the foot is facing down.

STEP 4

A. Slide the entire crutch back into the bag it came in and put it in the box.

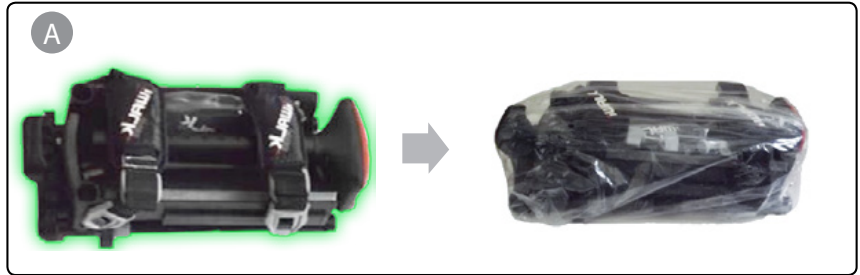

B. Slide the plastic bag containing the crutch parts in, with the wire tied end facing toward the opening.

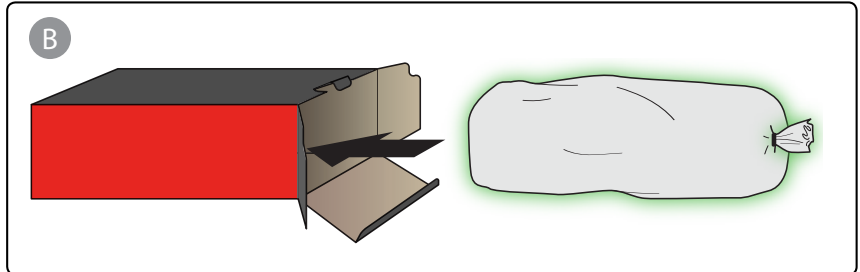

C. Place the User Guide on top of the bag, with the front side facing up.



FRONT

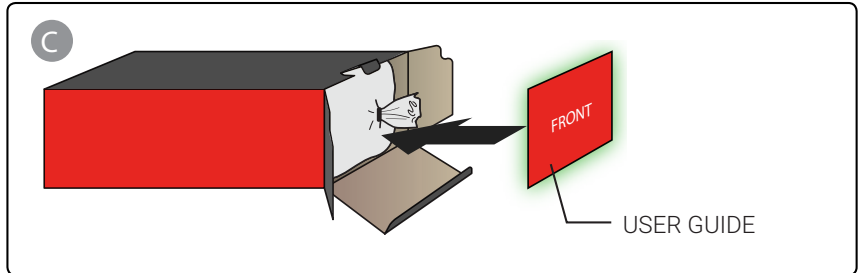

REGULATORY AND COMPLIANCE INFORMATION

- Intended Use Statement: This device is intended for single user, able bodied human under 126kg with need for single lower limb unloading during walking, without concurrent use of other assistive devices (cane or crutch) in normal indoor and outdoor environments between 0° C and 40° C.
- Expected Product Lifetime: 150 days at 6000 total steps per day on heaviest user; longer expected for smaller user.
- Cleaning Instructions: Rinse clean with fresh water, then allow to dry, ensuring that no liquid remains.
- ⚠ Device is not intended for unsupervised use by patients with significant balance issues or cognitive difficulties.
- ⚠ Cognitively impaired users must seek assistance from a person qualified to use the device.
- ⚠ Only use device after proper assembly in accordance with instructions by qualified personnel.
- ⚠ If you do not understand these instructions, stop and seek qualified assistance.
- ⚠ Device is intended for use by a single user only, not for rental or resale.
- ⚠ Flammability: This device does not incorporate self-extinguishing or fire retardant materials.
- ⚠ Do not expose to external sources of ambient heat or open flame. Do not store or leave in direct sunlight, and do not use when painfully hot to the touch until device is allowed to cool.
- ⚠ Do not place fingers or small appendages in or near holes or V-shaped openings, while in use or stationary.
- ⚠ Do not ingest any components of the device. Do not assemble or disassemble in the presence of small children.
- ⚠ Discontinue use if there is any evidence of soft tissue damage associated with use or wearing the device.
- ⚠ Device has no user serviceable parts. Follow original assembly instructions when replacing a part.
- ⚠ Transport in fully assembled and ready for use condition. If returning for service, follow Repackage Instructions.
- ⚠ If product changes performance during use, stop use instantly, & contact authorized distributor for resolution.
- ⚠ Essential Performance Statement: Essential Performance of this device is the ability to bear maximum user load in single limb standing without harm imparted to the user while allowing the device to be removable by the user who can elect to remain standing while choosing an alternate method of support.



iWALKFree Inc.
130 North Marina Drive
Long Beach CA 90803 USA



cepartner4U, Esdoornlaan 13, 3951
DB Maarn, The Netherlands



**HAVE A QUESTION?
NEED MORE HELP?**

Let us know!

Email: info@iwalk-free.com

Technical Assistance Hotline:

562-653-4222



Have this page open when calling iWALKFree for technical support.

